

NEW COLLECTION. 22

NUEVA COLECCIÓN. 22

Catálogo de novedades

Novelties catalogue

KRION
PORCELANOSA Grupo



4 Krion® Lux

L110 Nebula White

L508 Nebula Vanila

L107 Grey Stripes

L108 Snow Cloudy

L506 Coffee Cream

L109 Bianco Cloud

L507 Hickory

B829 Basic

36 Alluslate™

Capricce

Nostalgia

Amazonic

Materica

Peak

Bericcio

Calacatta

Forest

KRION LUX



Krion® Lux es un material compuesto mayoritariamente por mineral. Gracias a su composición no solo permite trabajar de igual forma que la madera, sino que además se puede termoformar y realizar uniones sin juntas para crear diseños únicos e ilimitados. Dispone de más de 100 colores, algunos de ellos retroiluminables lo que permite crear ambientes altamente personalizables.

El sistema de producción de Krion® Lux dota al material de ciertas particularidades que lo hacen exclusivo como, la carencia de poros, alta dureza, resistencia, durabilidad, facilidad de reparación, escaso mantenimiento y fácil limpieza.

Krion® Lux is a material composed primarily of minerals. Thanks to its composition, not only can it be worked in the same way as wood, but it can also be thermoformed and joined seamlessly to create an unlimited number of unique designs. More than 100 colours are available, some of them backlit, making it possible to create highly customisable ambiances.

The Krion® Lux production system gives the material certain exclusive features that make it unique, such as lack of pores, great hardness, strength, durability, ease of repair, minimal maintenance and easy cleaning.



Nebula White

L110



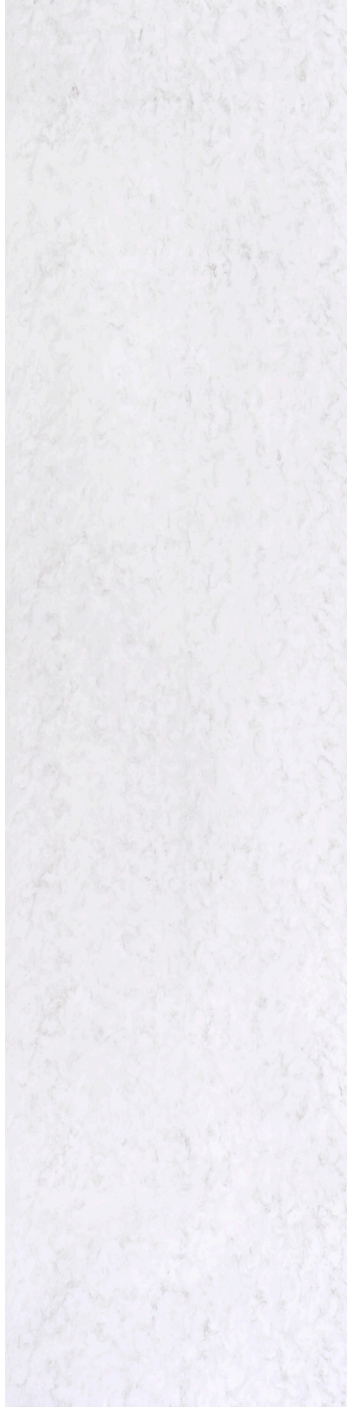

De extraordinaria blancura con vetas de tonalidades grisáceas, el modelo Nebula White recuerda a pequeños cúmulos de nubes, que otorgan de clase a cualquier proyecto donde se instale.

Of extraordinary whiteness with streaks of greyish tones, the Nebula White model is reminiscent of small cumulus clouds, which add class to any project where it is installed.

Krion® Lux · Nebula White · L110

3680 x 760 x 12 mm · 100318247



Nebula Vanila

L508





Nebula Vanila, con una base crema, contiene ligeras vetas doradas y caramelo que nos sugieren movimiento y fluidez, características que aportarán dinamismo y vigor a los proyectos.

Nebula Vanila es ideal para instalarlo en la recepción de hoteles, restaurantes o tiendas de lujo.

Nebula Vanila, with a cream-colored base, contains soft golden and caramel veins that suggest movement and fluidity, characteristics that will bring dynamism and vigour to projects.

Nebula Vanila is ideal for installation in the reception area of hotels, restaurants or luxury stores.

Krion® Lux · Nebula Vanila · L508

3680 x 760 x 12 mm · 100318253



Grey Stripes

L107





Grey Stripes se presenta como una opción diferenciadora con el que crear proyectos equilibrados y asombrosamente modernos. Bañado por una multitud de líneas de varias tonalidades de gris sobre un fondo blanco, este nuevo modelo de la serie Luxury denota carácter y atractivo.

Grey Stripes is presented as a differentiating option with which to create balanced and surprisingly modern projects. Bathed in a multitude of lines in various shades of grey on a white background, this new model from the Luxury series denotes character and appeal.

Krion® Lux · Grey Stripes · LI07

2500 x 760 x 6 mm · 100307942

3680 x 760 x 12 mm · 100307934



Snow Cloudy

L108





De carácter pétreo, salpicado por pequeños gránulos y delicados y sinuosos veteados de color gris sobre un fondo blanco, nace Snow Cloudy.

Snow Cloudy has a stony character, dotted with small granules and delicate, sinuous grey veins on a white background.

Krion® Lux · Snow Cloudy · L108

2500 x 760 x 6 mm · 100307935

3680 x 760 x 12 mm · 100307937



Coffee Cream

L506





De aspecto pétreo, cargado de sinuosas vetas con un suave movimiento de tonos avellanas, cafés y canela, sobre un suave fondo beige. Inspirado en materiales nobles y patrones que evocan un carácter único.

Stony in appearance, full of winding veins with a soft movement of hazelnut, brown and cinnamon tones, on a soft beige background. Inspired by noble materials and patterns that evoke a unique character.

Krion® Lux · Coffee Cream · L506

2500 x 760 x 6 mm · 100307939

3680 x 760 x 12 mm · 100307950



Bianco Cloud

L109





La plancha Bianco Cloud destaca por su fondo blanco y vénulas grises que aportan modernidad y luminosidad a los ambientes. Su decorado homogéneo permite crear cualquier tipo de proyecto tanto residencial como comercial.

The Bianco Cloud sheet stands out for its white background and grey streaks that bring modernity and luminosity to the rooms. Its homogeneous décor allows the creation of any type of residential or commercial project.

Krion® Lux · Bianco Cloud · LI09

2500 x 760 x 6 mm · 100312819

3680 x 760 x 12 mm · 100312820



Hickory

L507





Inspirada en la naturalidad de la madera, de color café rojizo oscuro con vetas de color chocolate. Aporta elegancia y estilo a cualquier proyecto, abierto a multitud combinaciones.

Inspired by the nature of wood, dark reddish-brown to chocolate brown in colour, with pronounced grain. It brings elegance and style to any project, open to a multitude of combinations.

Krion® Lux · Hickory · L507

2500 x 760 x 6 mm · 100312821

3680 x 760 x 12 mm · 100312792



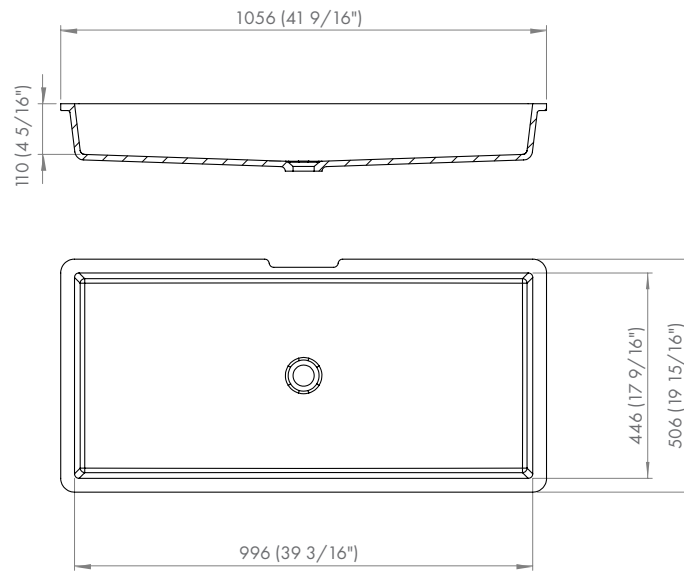

Basic B829

100x45



Basic B829

100x45 1100 E · 100312972

Lavabo de encastre de gran formato rectangular de 1000 x 450 mm y una profundidad de 110 mm, elaborado con Krion® Snow White 1100 con esquinas redondeadas. Destaca por sus propiedades de no proliferación de bacterias, resistencia, facilidad de limpieza, facilidad de reparación...

A large rectangular built-in washbasin measuring 1000 x 450 mm with a depth of 110 mm, made of Krion® Snow White 1100 with rounded corners. It stands out for prevents the proliferation of bacteria, resistance, easiness of cleaning, easiness of repair...



ALLUSLATE™
aluminium cladding





Alluslate™ es un revestimiento mural de gran formato, creado con el objetivo de decorar espacios interiores, tanto comerciales como residenciales.

Estos paneles son decorados mediante un sistema de impresión que consigue una alta calidad de imagen, y posteriormente son protegidos por un recubrimiento de gran resistencia.

Se presentan en 2 tipos diferentes de acabados, el texturizado (Matt) que permite su mecanización y plegado mediante técnicas sencillas y curvado en frío, y el acabado brillo (Glazed) que se puede mecanizar.

Este material está destinado para su uso en revestimiento, equipamiento o mobiliario, dando al espacio infinidad de posibilidades.

Alluslate™ is a large format wall cladding, created with the aim of decorating interior spaces, either commercial or residential.

These panels are decorated by means of a printing system that achieves a high quality image, and are subsequently protected by a highly resistant coating for their conservation.

They are available in 2 different finishes: the textured finish (Matt) which can be machined and folded using simple techniques and cold bending, and the glossy finish (Glazed) which can be machined.

This material is intended for use in cladding, equipment or furniture, giving the space endless possibilities.

Alluslate™ se compone de un panel base compuesto por dos láminas de aluminio, delantera y trasera, y un núcleo de resina termoplástica de baja densidad con carga mineral retardante al fuego, componiendo finalmente el panel un espesor de 4mm.

La impresión de la cara delantera se efectúa mediante un sistema de impresión digital utilizando tintas de altas prestaciones. Previamente a la impresión, se realiza un tratamiento de la superficie preparándola para poder imprimirse en las mejores condiciones técnicas. De esta forma se asegura un buen anclaje de las tintas obteniendo una gráfica definida de alta resolución.

Alluslate™ consists of a base panel composed of two front and rear aluminium sheets and a core of low density thermoplastic resin with a fire retardant mineral filler, the final panel thickness being 4mm.

The front side is printed by means of a digital printing system using high performance inks. Prior to printing, the surface is treated to prepare it for printing in the best technical conditions. This ensures a good fixation of the inks, obtaining a defined, high-resolution graphic.



1200 x 2600 x 4 mm · 7kg/m²

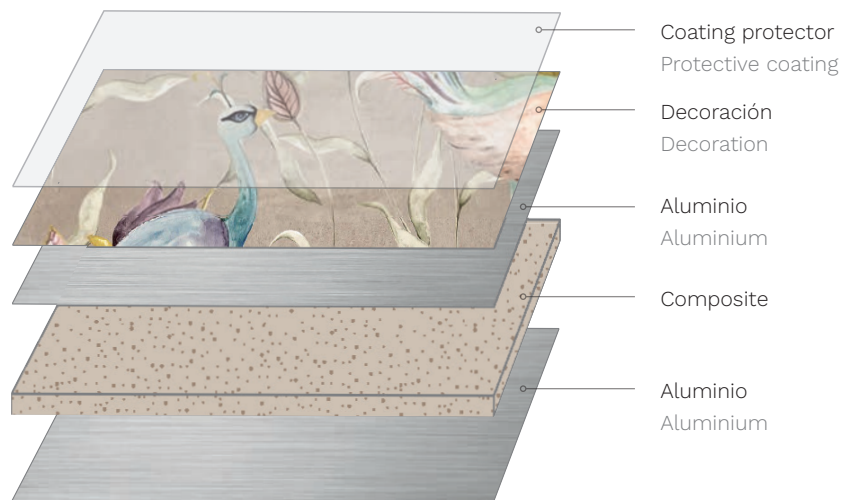

Posibilidad de reciclaje.
Possibility of recycling.



Matt

Tras la impresión gráfica se aplica un coating técnico que dotará finalmente a la superficie de altas prestaciones técnicas y mediante el cual se obtiene el acabado del panel. (Matt o Glazed).

After the graphic printing, a technical coating is applied which will ultimately provide the surface with high technical performance and by means of which the panel finish is obtained. (Matt or Glazed).

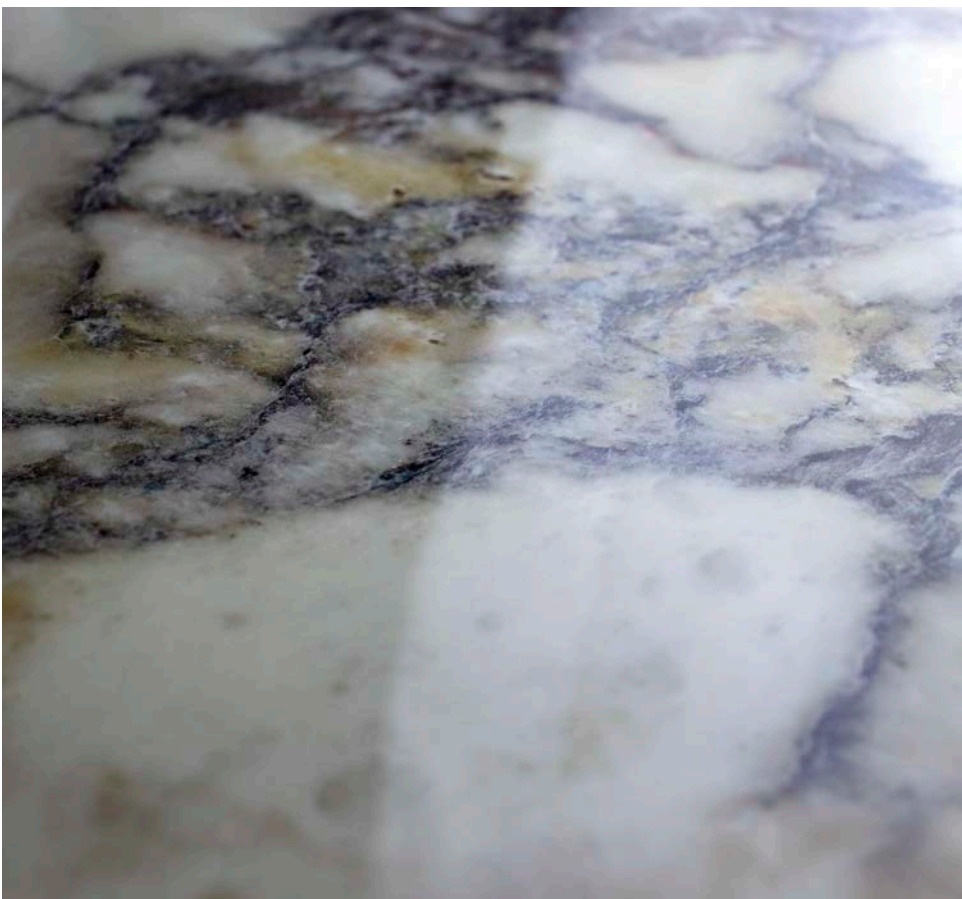

Glazed



Material resistente y de fácil limpieza.

Resistencia tanto a la humedad como al contacto con el agua, con un mantenimiento sencillo frente a manchas cotidianas.

Resistant and easy-to-clean material.

Resistant to both damp and contact with water, with easy maintenance against everyday stains.



Bajo peso y gran superficie.

Facilidad de transporte e instalación debido al bajo peso del panel. Además, se ahorra tiempo en la instalación ya que abarca una gran superficie.

Low weight and large area.

Easy to transport and install due to the low weight of the panel. In addition, it saves time during installation as it covers a large area.

Amplia variedad.

Posibilidad de decoración amplia y que aporta características técnicas adicionales. Variedad de imagen para el mismo modelo, evitando la repetitividad de diseños.

Wide variety.

Wide range of decoration possibilities and additional technical features. Variety of image for the same model, avoiding repetitiveness of designs.





Mecanizado sencillo.

El mecanizado se realiza con herramientas propias del sector de carpintería metálica. Se permite el plegado en frío mediante técnicas sencillas (sólo para acabados Matt).

La posibilidad de mecanizar tanto en taller como en obra de forma fácil, hace que se puedan realizar reformas de una forma ágil. No genera polvo en el corte.

Simple machining.

Machining is carried out with tools specific to the metal carpentry sector. Cold bending is permitted using simple techniques (for Matt finishes only).

The possibility of machining both in the workshop and on site in an easy way makes it possible to carry out renovations quickly. No dust produced during cutting.



Capricce · Nero · Matt
1200x2600x4 mm



ALGUSTINE

Capricce

Matt

Capricce

Capricce · Nero · Matt
1200x2600x4 mm



Panel A



Panel B



Panel C

Capricce

Capricce · Nocce · Matt
1200x2600x4 mm



Panel A



Panel B



Panel C



Nostalgia · Blanco · Matt
1200x2600x4 mm

Nostalgia

Matt

Nostalgia

Nostalgia · Blanco · Matt
1200x2600x4 mm



Panel A



Panel B



Panel C

Nostalgia

Nostalgia · Beige · Matt
1200x2600x4 mm



Panel A



Panel B



Panel C



Amazonic · Green · Matt

1200x2600x4 mm

Amazonic

Matt

Amazonic

Amazonic · Green · Matt
1200x2600x4 mm



Panel A



Panel B



Panel C

Amazonic

Amazonic · Light · Matt
1200x2600x4 mm



Panel A



Panel B



Panel C



Materica · Original · Matt
1200x2600x4 mm

Materica

Matt

Materica

Materica · Sand · Matt
1200x2600x4 mm



Diseño secuencial. Existen varias caras por color.

Sequential design. There are several designs per model.

Materica

Materica · Nut · Matt
1200x2600x4 mm



Diseño secuencial. Existen varias caras por color.
Sequential design. There are several designs per
model.

Materica

Materica · Original · Matt
1200x2600x4 mm



Diseño secuencial. Existen varias caras por color.

Sequential design. There are several designs per model.

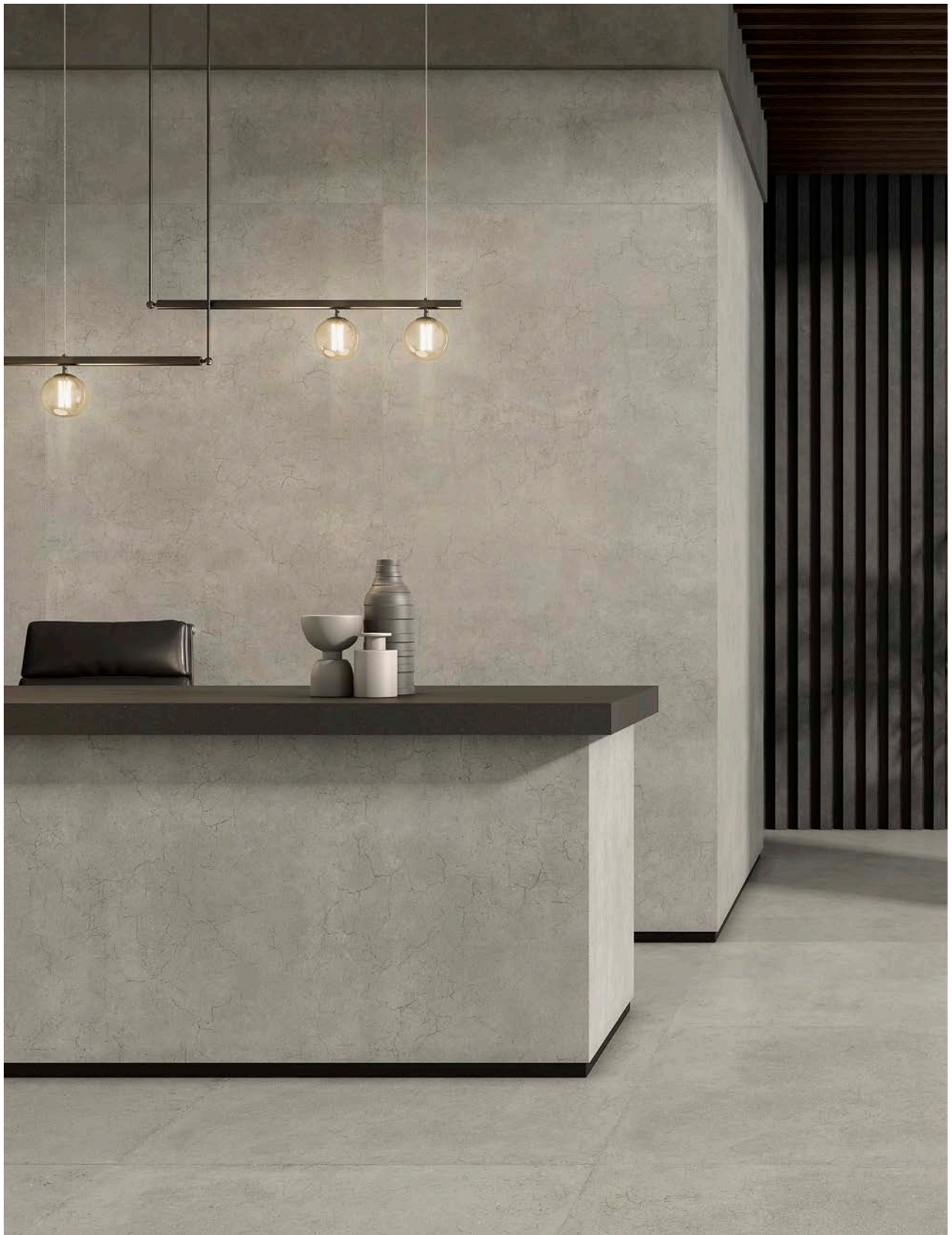

Peak · Acero · Matt
1200x2600x4 mm

Peak

Matt

Peak

Peak · Acero · Matt
1200x2600x4 mm



Diseño secuencial. Existen varias caras por color.
Sequential design. There are several designs per
model.

Peak

Peak · Topo · Matt
1200x2600x4 mm



Diseño secuencial. Existen varias caras por color.
Sequential design. There are several designs per
model.



Bericcio · Bronze · Matt
1200x2600x4 mm



Bericcio

Matt

Bericcio

Bericcio · Bronze · Matt
1200x2600x4 mm



Panel A

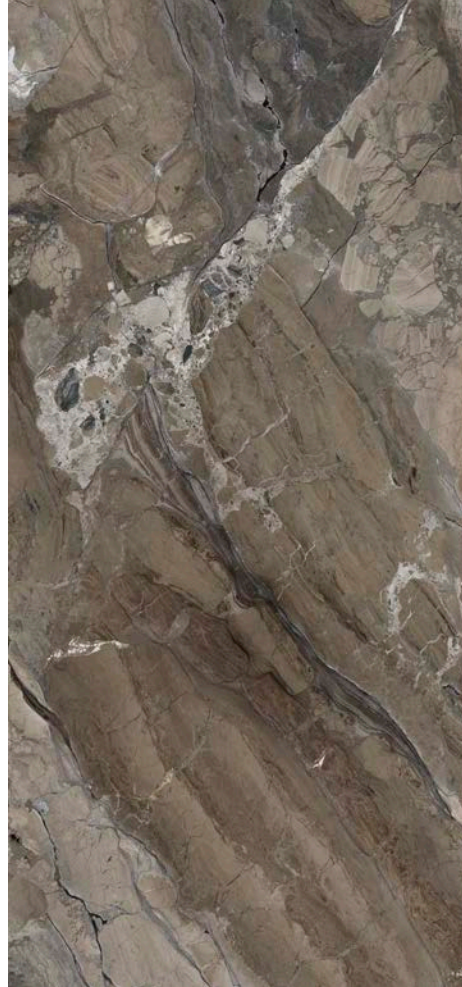

Panel B



Panel C

Bericcio

Bericcio · Grey · Matt
1200x2600x4 mm



Panel A



Panel B



Panel C



Calacatta · Viola · Glazed
1200x2600x4 mm

Calacatta

Glazed

Calacatta

Calacatta · Viola · Glazed
1200x2600x4 mm



Panel A



Panel B

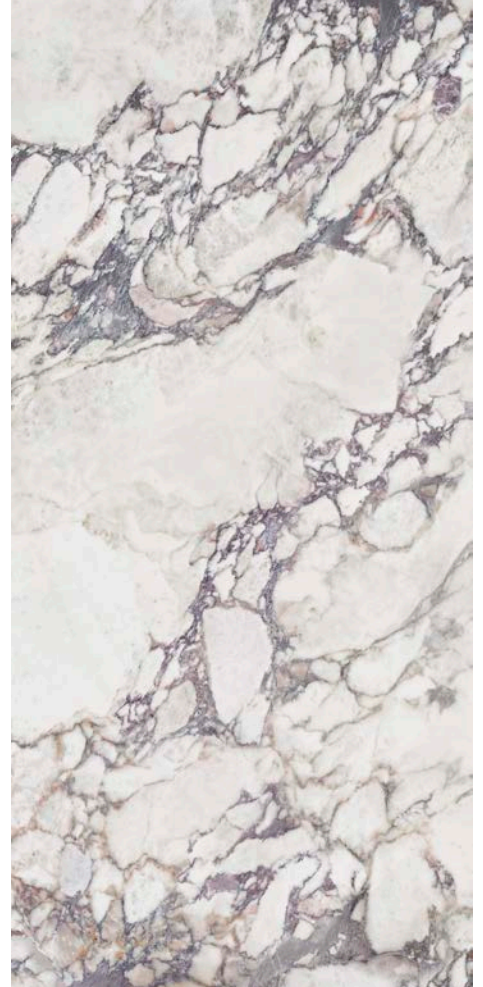

Panel C

Calacatta

Calacatta · Grey · Glazed
1200x2600x4 mm



Panel A



Panel B

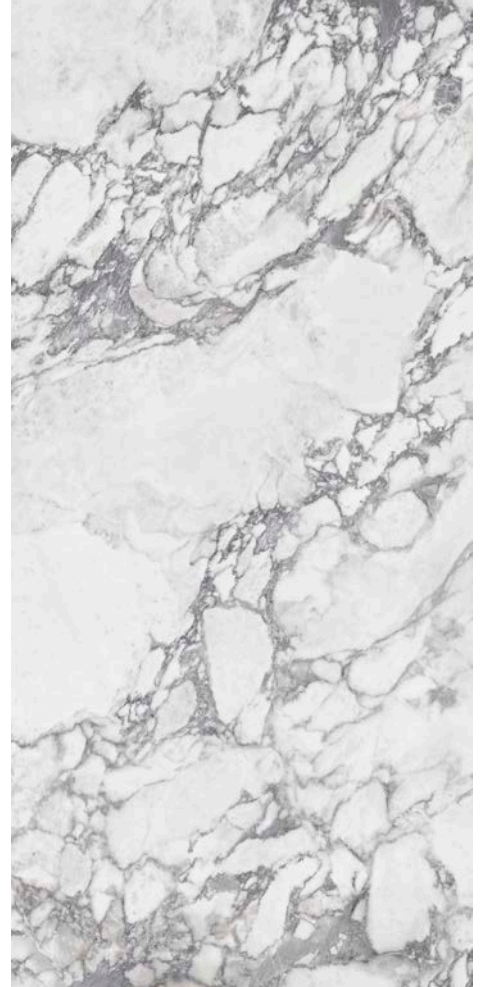

Panel C



Forest · Green · Glazed
1200x2600x4 mm

Forest

Glazed



Forest

Forest · Green · Glazed
1200x2600x4 mm



Panel A

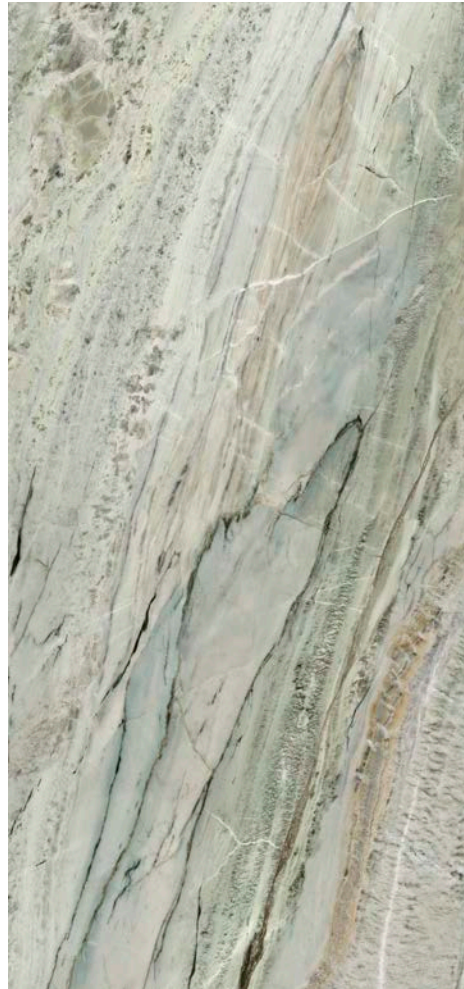

Panel B

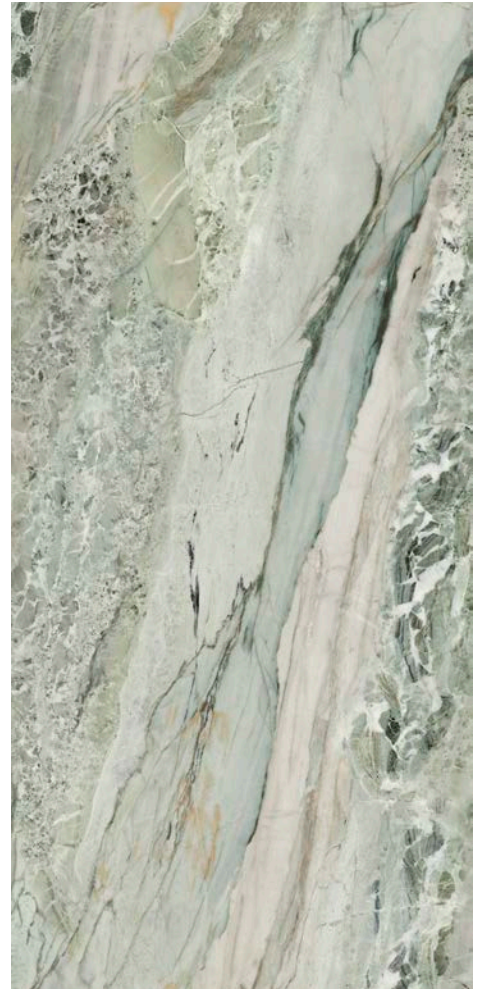

Panel C

Forest

Forest · Grey · Glazed
1200x2600x4 mm



Panel A



Panel B

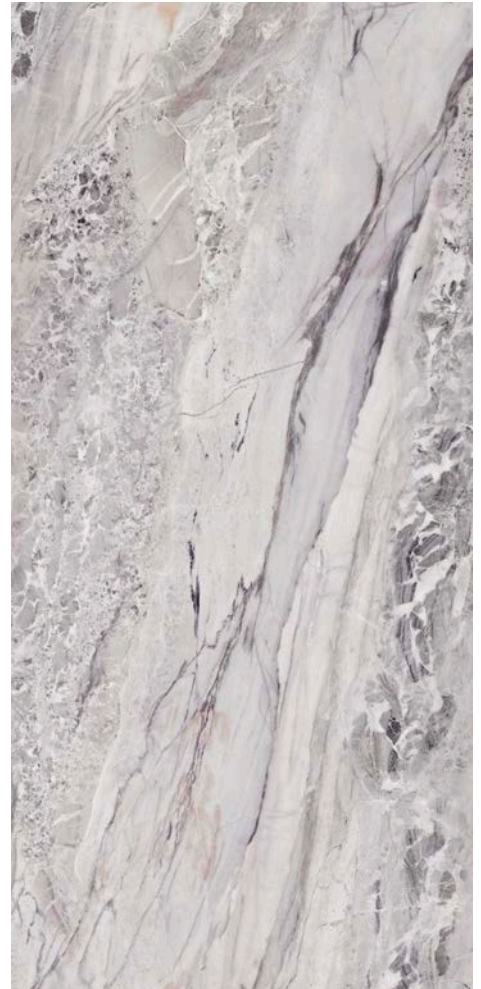

Panel C



Ctra. Vila-real-Puebla de Arenoso (CV20) Km 1 · 12540
VILA-REAL (CASTELLÓN) SPAIN
PO/BOX. 372 - Tel: (+34) 964 50 64 64 Fax. (+34) 964 50 64 81
krion@krion.com / www.krion.com

Aviso Legal: Las imágenes, textos y datos son propiedad de KRION SOLID SURFACE, S.A.U., con domicilio en Carretera Vila-real – Puebla de Arenoso (CV-20), 12.540 Vila-real (Castellón). Se requiere su consentimiento expreso y por escrito para la utilización y divulgación, ya sea parcial o total, de los referidos contenidos. Corresponde a KRION SOLID SURFACE, S.A.U. el ejercicio exclusivo de los derechos de explotación de los mismos en cualquier forma, y en especial los derechos de reproducción, distribución, comunicación pública y transformación. Todo este material está protegido por la legislación de la propiedad intelectual y su uso indebido puede ser objeto de sanciones, incluso penales. La finalidad de este documento es meramente informativa y los datos ofrecidos en el mismo son de carácter genérico estándar. Para más información técnica y específica de los materiales, acudir a las notas y boletines técnicos de KRION®.

Legal notice: The images, texts and data are the property of KRION SOLID SURFACE, S.A.U., with registered offices at Carretera Vila-real – Puebla de Arenoso (CV-20), 12.540 Vila-real (Castellón). The express written consent of KRION SOLID SURFACE S.A.U., shall be required for the partial or total use or disclosure of the said material. KRION SOLID SURFACE, S.A.U., holds sole rights over all forms of use of the said material and, in particular, the right to its reproduction, distribution, public communication and transformation. All the said material is protected by intellectual property laws and any undue use may result in penalties, even of a criminal kind. The purpose of this document is merely informative and the information offered is for a standard. For more technical and specific information of the materials, check the notes and technical bulletins of KRION®.



BY APPOINTMENT TO
H.R.H. THE PRINCE OF WALES
MANUFACTURER AND DISTRIBUTOR
OF CERAMIC TILES AND BUILDING PRODUCTS.
PORCELANOSA GROUP LIMITED

PORCELANOSA Grupo